

# MORTEX

## Cantilever Form Shapes

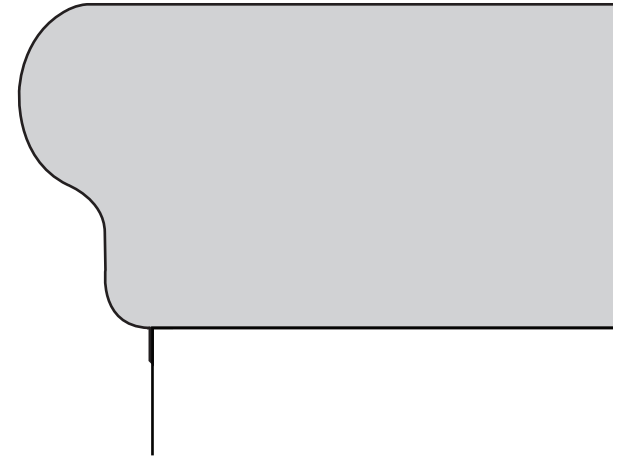

Stone Edge

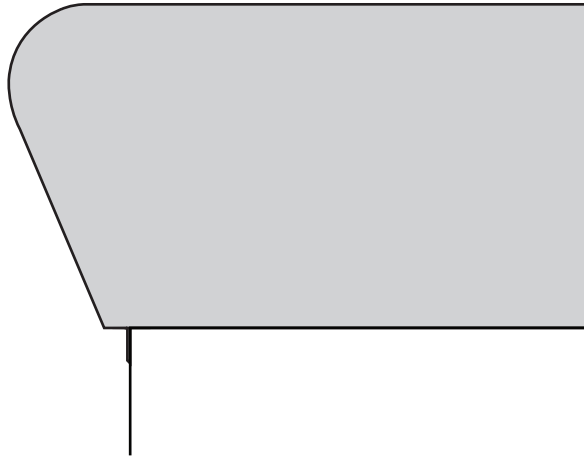
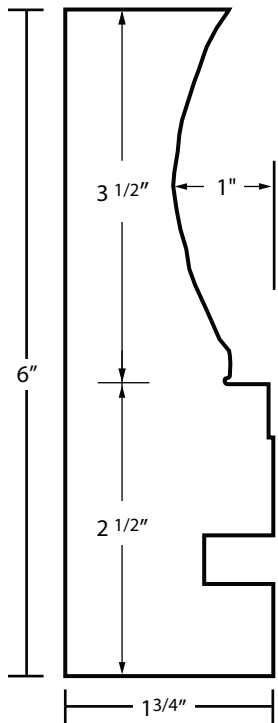

Keystone

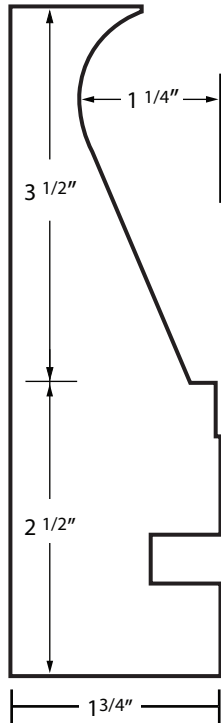

Poly

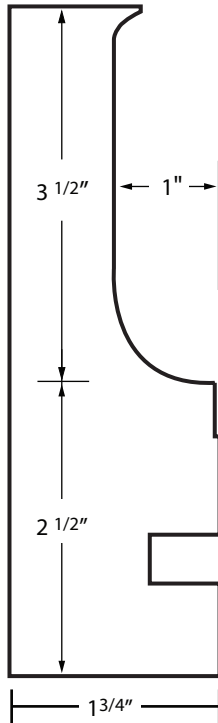

French Curve

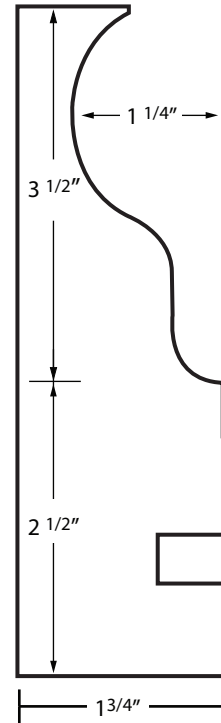

Commercial

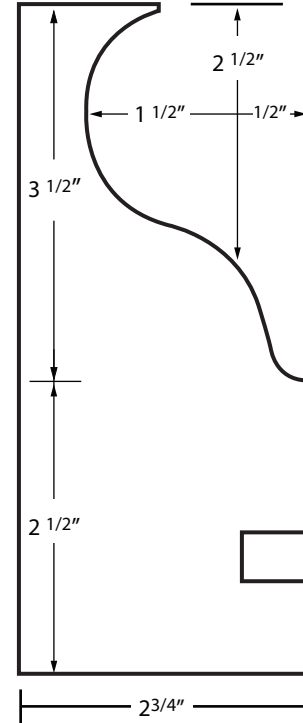

Hemi

